

# JB SANITARY

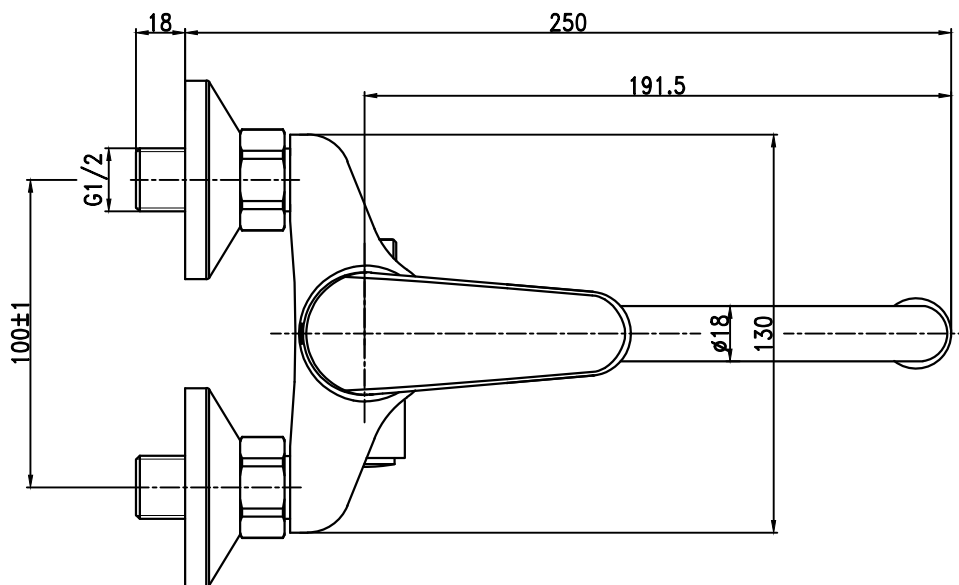
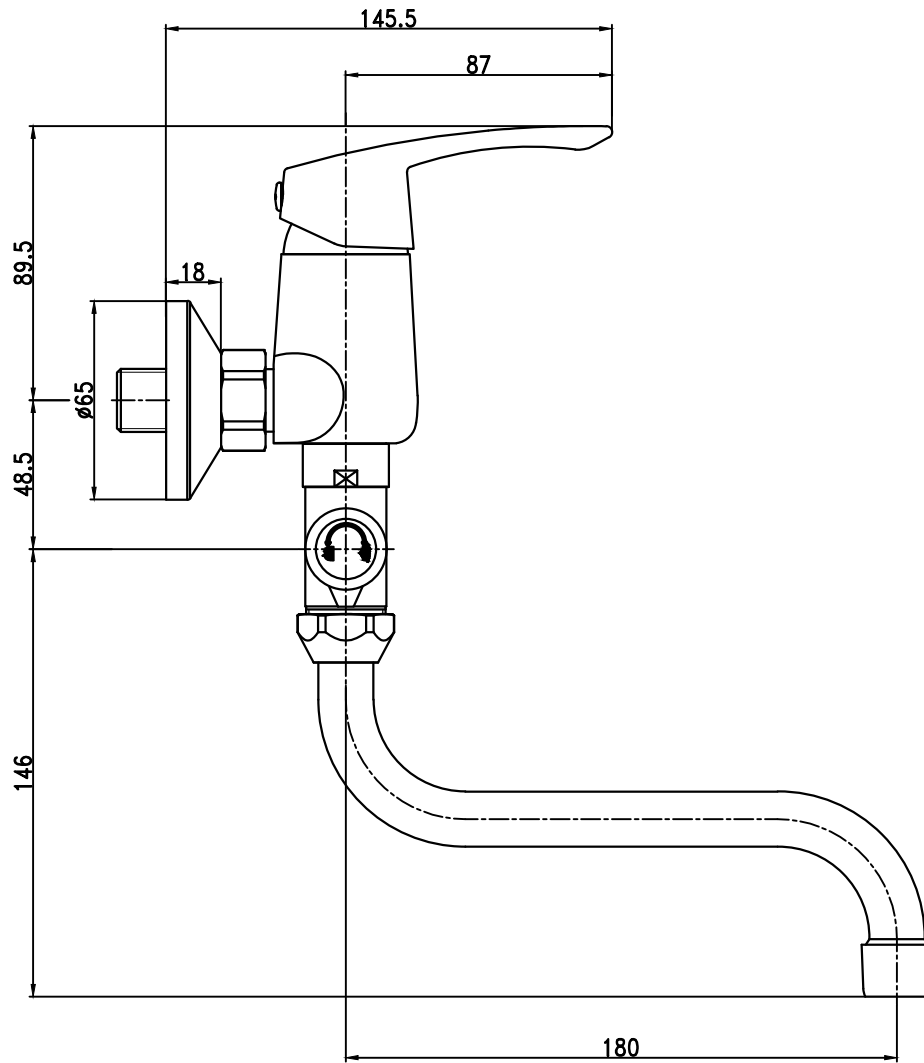

**L10 32 30**